

DISPLACEMENT SENSORS

CD1 Series



Cable Type

(Sensing range : 30±4mm)
• CD1-30N / P / CN / CP

(Sensing range : 250±150mm)
• CD1-250N / P / CN / CP

(Sensing range : 50±10mm)
• CD1-50N / P / CN / CP

(Sensing range : 100±35mm)
• CD1-100N / P / CN / CP

(Sensing range : 130±50mm)
• CD1-130N / P / CN / CP

Applications

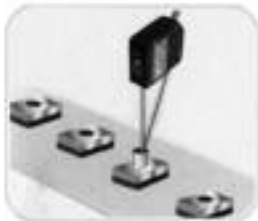

Checking mechanical parts.



Level check of food package

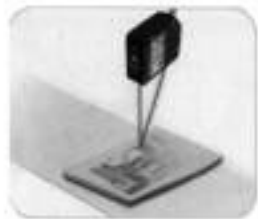

Checking height of components.



Cap of bottled beverage

- **PSD (Position Sensing Device) optical system.**
- **Self-contained Displacement Laser sensor.**
- **Remote Teach input for added flexibility.**
- **Good for OEM applications.**

Control Panel

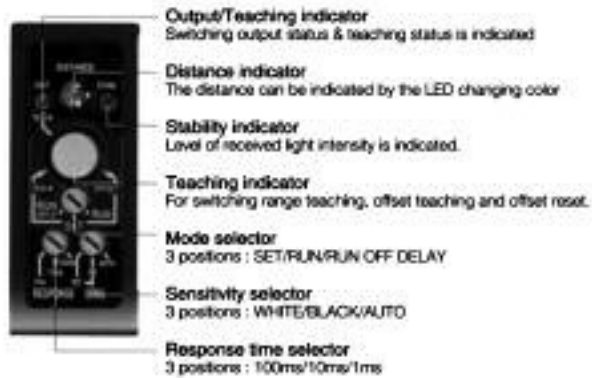

Teach-in System

The CD1 is simple to setup and easy to operate. It is not necessary to make manual adjustments to the sensor, just push the button.



All-in-one Solution

The amplifier and sensor are built-in, the CD1 is a complete self-contained sensor.



Remote Teaching Input

The teaching procedure can be carried out remotely by using the remote teach input. There is no need to perform this step at the sensor. This feature is good for OEM machine builders.

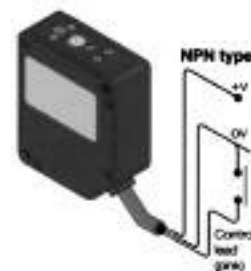

DISPLACEMENT SENSORS

M12 Exclusive Connector CD3CN-S. Applicable for both CD1 and CD3 (2M standard. 5M type is available as option)

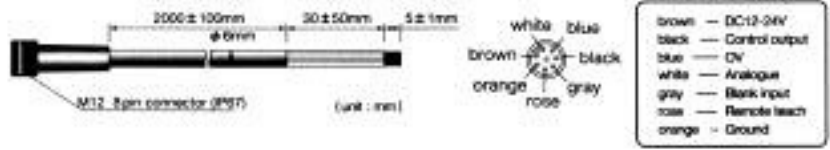

Dual Output - Digital On / Off and Analog.

There is a choice of NPN or PNP transistor for the control output, choose the model number based on the desired type.

The 4 to 20 mA analog output is standard on both types.

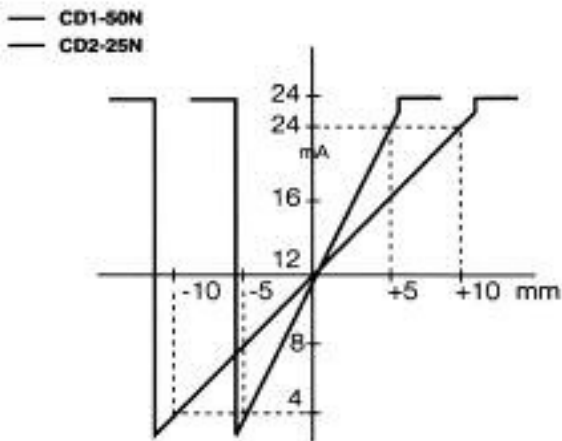

Easy set-up and Measuring

The High and Low limit of the measuring range can be set.

- 1: Go to the SET mode.
- 2: Teach the High and Low limit using the workpiece.
- 3: Return to RUN mode.

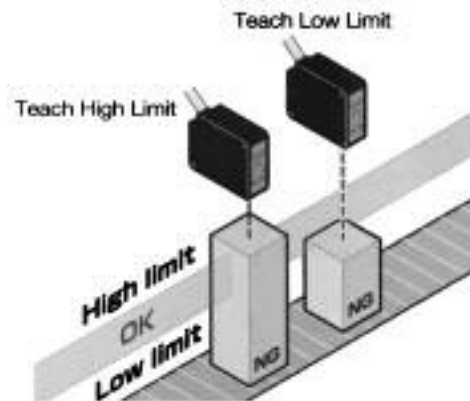

Installation Precautions for Best Accuracy

To obtain the best accuracy, the sensor head must be oriented in the direction shown below.

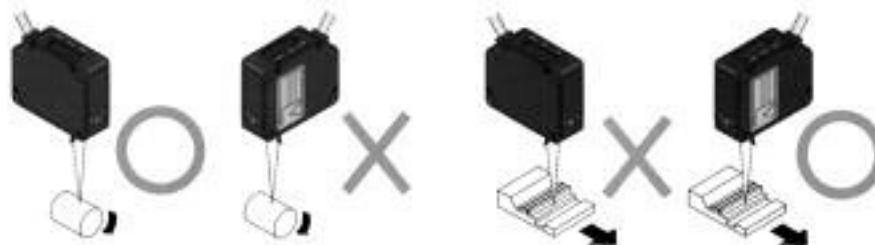

Dimensions

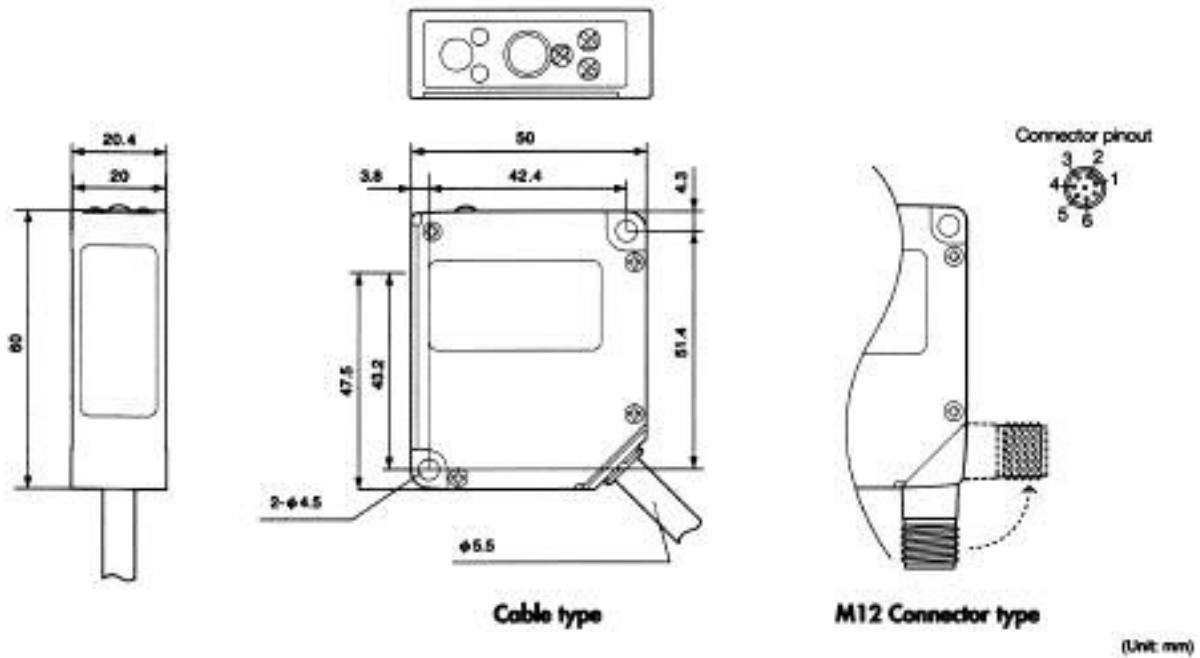

Specifications

Cable	CD1 Series, PSD system Laser type Displacement Sensor				
	CD1-30N/P	CD1-50N/P	CD1-100N/P	CD1-130N/P	CD1-250N/P
M12 Connector	CD1-30CN/CP	CD1-50CN/CP	CD1-100CN/CP	CD1-130CN/CP	CD1-250CN/CP
Transistor output	N = NPN output, P = PNP output				
Measuring range	30±4mm	50 ±/ 10mm	100 ±/ 35mm	130 ±/ 50mm	250 ±/ 150mm
FS (full scale)	8mm	20mm	70mm	100mm	300mm
Light source	Class 2 Laser, 650nm, Max 3.3mW				
Projected spot size	φ0.1mm	φ0.5mm	0.5 X 1.2 mm	0.5 X 1.5 mm	0.8 X 1.2 mm
Power supply	12 - 24V DC (-5 to +10%)				
Current consumption	Max 120mA (DC12V), 75mA (DC24V), including analog output current				
Resolution (typical value)	(Unit : Micron. Under AUTO sensitivity. White ceramic as an object)				
(Response Speed 100msec)	1	3	15	20	150
(Response Speed 10msec)	3	10	50	70	500
(Response Speed 1msec)	10	30	150	200	1500
Linearity	±/ 2% FS	±/ 1% FS	±/ 2% FS	±/ 3.6% FS	±/ 5% FS
Temperature drift	±/ 0.02% FS/ Celsius				
Response speed	100msec / 10msec / 1msec selectable				
Sensitivity adjustment	SET / FIX / AUTO				
Analogue output	4-20mA				
Control output	NPN or PNP, Max 100mA/DC30V, Residual Voltage Max 1.8V				
Distance indicator	Red = Near, Orange = Middle, Green = Far, Red/Green = Error *Remark : Errors as "out of measuring range", "Too high reflection", etc				
Stability indicator	Green = Stable, Red = Error, No light = Unstable, need adjustment				
Output indicator	Orange = Output				
Teach-in indicator	Green = Input, Red = Error				
Blanking input	NPN = Gray wire to 0V, PNP = Gray wire to +V				
Delay function	Off delay 40msec				
Ambient illuminance	Sun light : Max 10,000 lux, Incandescent Lamp = Max 3,000 lux				
Operating temperature	-10 to 40 degree C				
Operating humidity	35 to 95% RH				
Material	Zinc diecast				
Protection / Noise regulation	IP67, CE				
Warm-up period	30 minutes				